

Raspberry Pi Enabled ATV/Microwave Test Equipment

Dave G8GKQ

The logo for BATC, consisting of the letters 'BATC' in white on a black rectangular background, which is tilted and surrounded by blue curved lines.

Topics

- The Hardware
- Capabilities
- Test Equipment
- Web Control/view



The logo for BATC, featuring the letters 'BATC' in white on a black rectangular background, which is tilted and surrounded by blue circular motion lines.

BATC

Portsdown 4 Hardware

7 inch Touchscreen

Raspberry Pi 4

Portsdown 4 Hardware

BATC

BATC Portsdown 4 DATV System Main Menu

TX		RX	M2	M3
Modulation	Encoder	Output to	Format	Source
32QPSK	H264	Lime Mini	4:3	PI Cam
Freq	Sym Rate	FEC	Band/Tvtr	Lime Gain
437 MHz	333	2/3	70_cm	88
EasyCap	Caption	Audio	Atten	Att Level
Comp Vid	On	Auto	NONE	-10.00
Preset 1	Preset 2	Preset 3	Preset 4	Store
146.5_333	437_1MS	1255_HD	437-Ugly	Preset

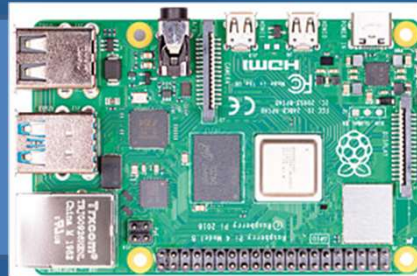

The logo for BATC, featuring the letters 'BATC' in white on a dark blue rectangular background, which is partially enclosed by a blue circular swoosh.

BATC

Portsdown 4 Capabilities

- DVB-S/S2 and DVB-T Transceiver
- SSB/FM/CW Transceiver (Langstone)
- Video Stream Transmitter and Receiver
- Test Equipment
- Utilities

Example Builds



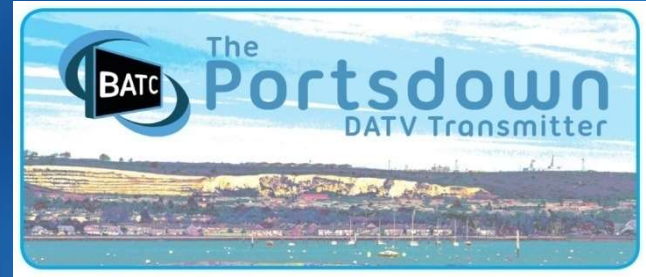

ATV/Microwave Test Equipment



Test Equipment

- BandViewer
- Signal Generator
- Noise Figure Indication
- Noise Level Meter
- Power Meter
- Frequency Sweeper
- XY Display
- DMM Display/logger



Band Viewer

- Narrow sweep (20 MHz) spectrum analyser
- LimeSDR, Pluto, RSPdx, Airspy R2 or RTL-SDR
- 2 MHz to 30 GHz
- Very useful as a “Panadapter”
- Accurate relative levels
- Dynamic Range Limited by SDR

Weak Signal Work

BATC

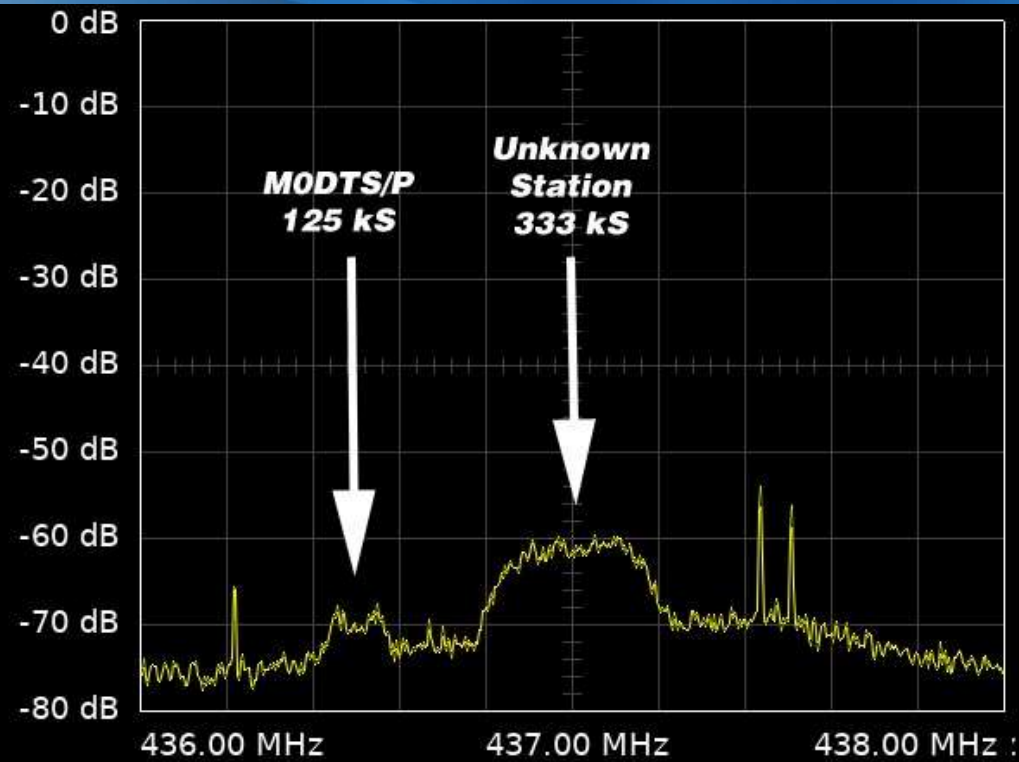

Gain
Menu

100%

90%

70%

50%

30%

Back to
Settings

Freeze

Portsdown Band Viewer

DATV Weak-signal Use

BATC



BATC

Peak Hold

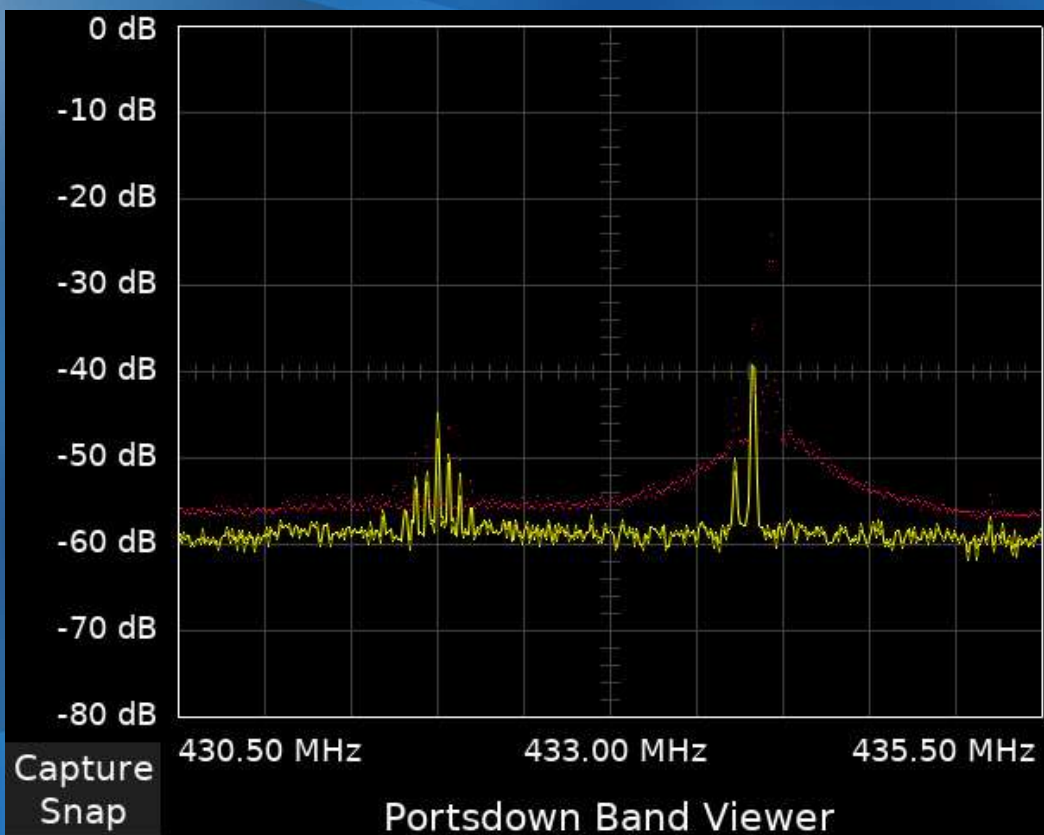

Marker
Menu

Peak

Peak
Hold

Manual

<-

->

Markers
Off

Return to
Main Menu

Freeze

BATC

Pluto 50 MHz Span

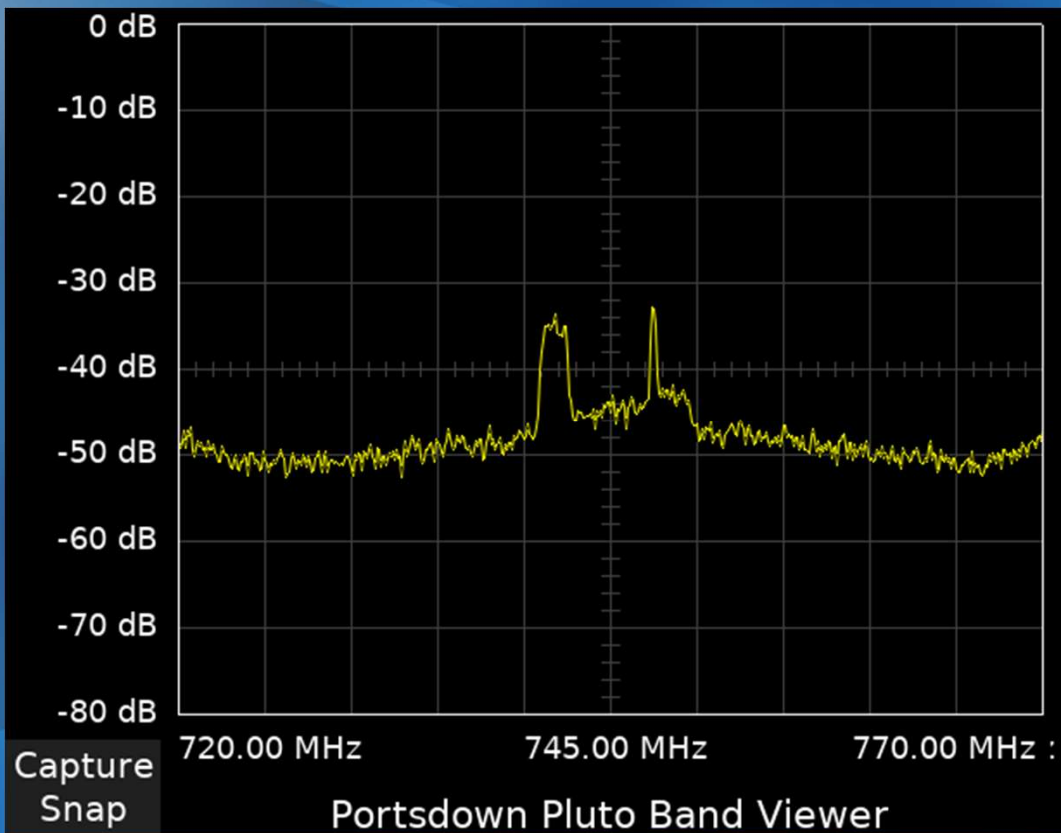

Span
Menu

2 MHz

5 MHz

10 MHz

20

50

Back to
Settings

Freeze

BATC

Waterfall

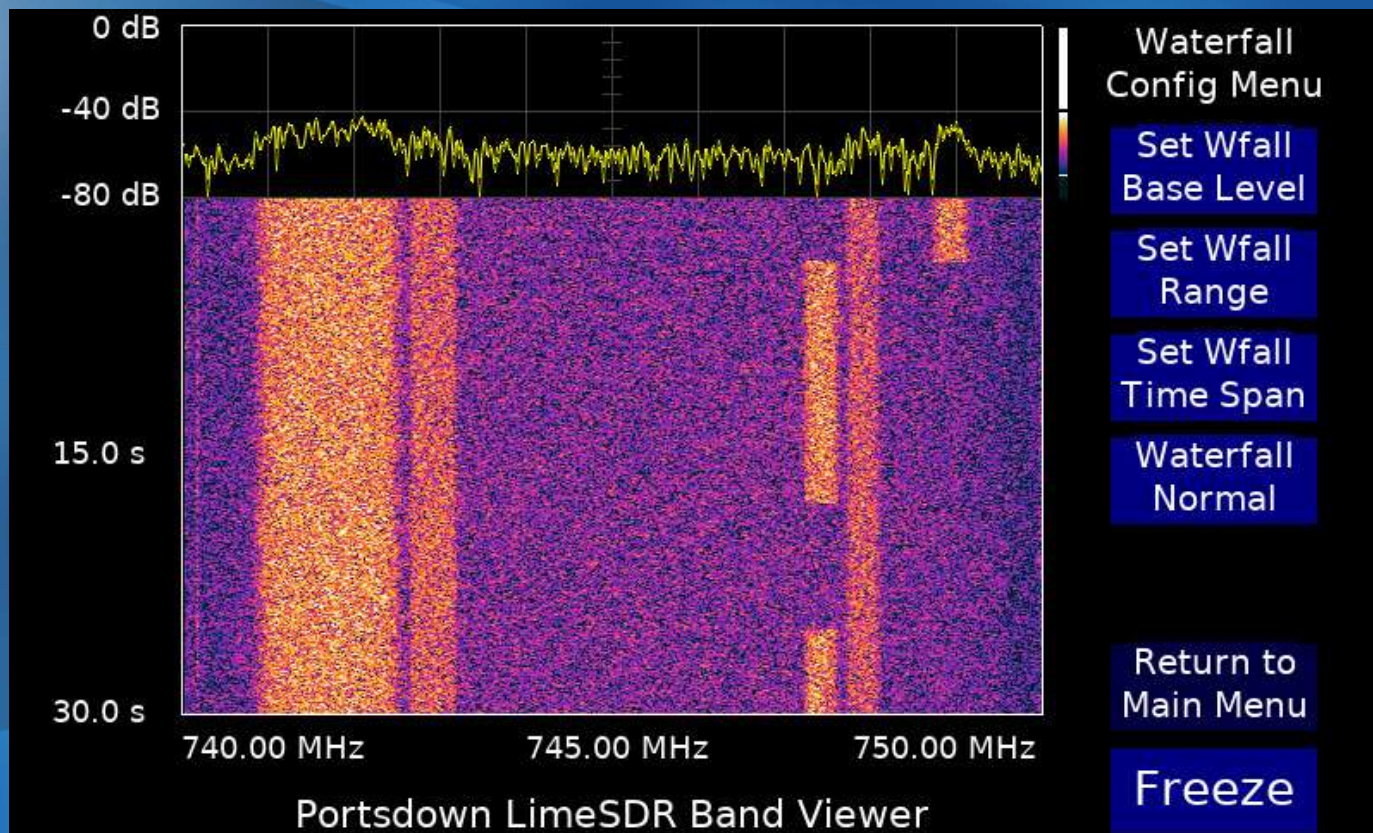



Signal Generator

- Simple Interface to Multiple Sources
- Approximate Amplitude Calibration using Look-up tables
- Some sources not clean
- Covers 1 Hz to 30 GHz

BATC

Signal Generator

- Sources

- Pluto SDR - 6 GHz
- Pluto SDR x5 - 30 GHz
- LimeSDR Mini - 3.5 GHz
- ADF4351 - 4.4 GHz
- ADF5355 - 13.6 GHz
- AD9850 - 1 Hz to 50 MHz

- Elcom Source



- Nort SLO

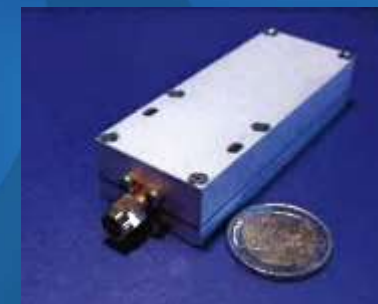

BATC

Sig Gen Control

Portsdown Signal Generator Control Panel

Lime Mini

OFF

Cal Lime

Exit

ON

+ + + + + + + + +
1,255.000,000

- - - - - - - - -

+ +
+ 1.5 dBm

- -

Save

Recall

Lime Gain = 77

BATC

LF Signal Generator

- AD9850 DDS Covers 1 Hz – 50 MHz

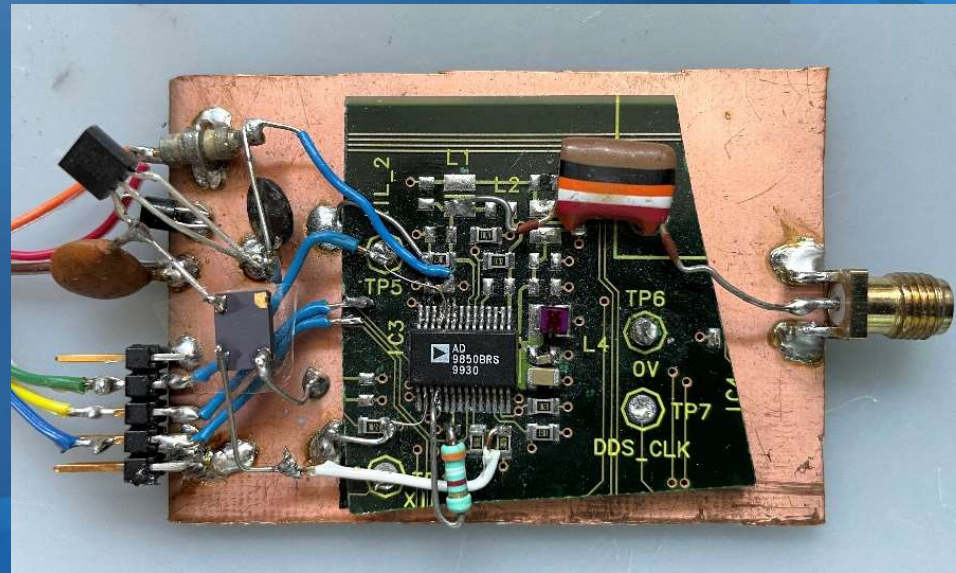

The logo for BATC (Bristol Astronomy Technology Centre) is located in the top left corner. It consists of the letters 'BATC' in white, bold, sans-serif font, set against a dark blue, trapezoidal background. This background is surrounded by several concentric, glowing blue circles of varying sizes, creating a sense of depth and motion.

BATC

Noise Figure Indication

- Use a Noise Source switched at ~ 4 Hz
- Measure Average Noise Power On & Off
- Calculate Noise Figure
- After calibration, calculate gain
- Pluto or LimeSDR



NF Measurement – How?

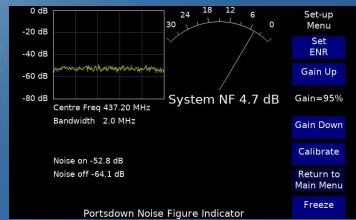

Display Ribbon Cable

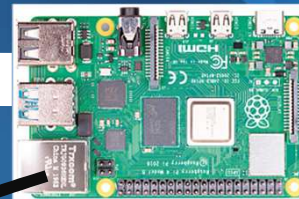

USB Cable

3v3 Switching Signal



28v

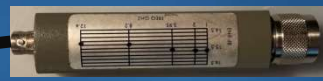

Noise Source



Device Under Test



LimeSDR Mini

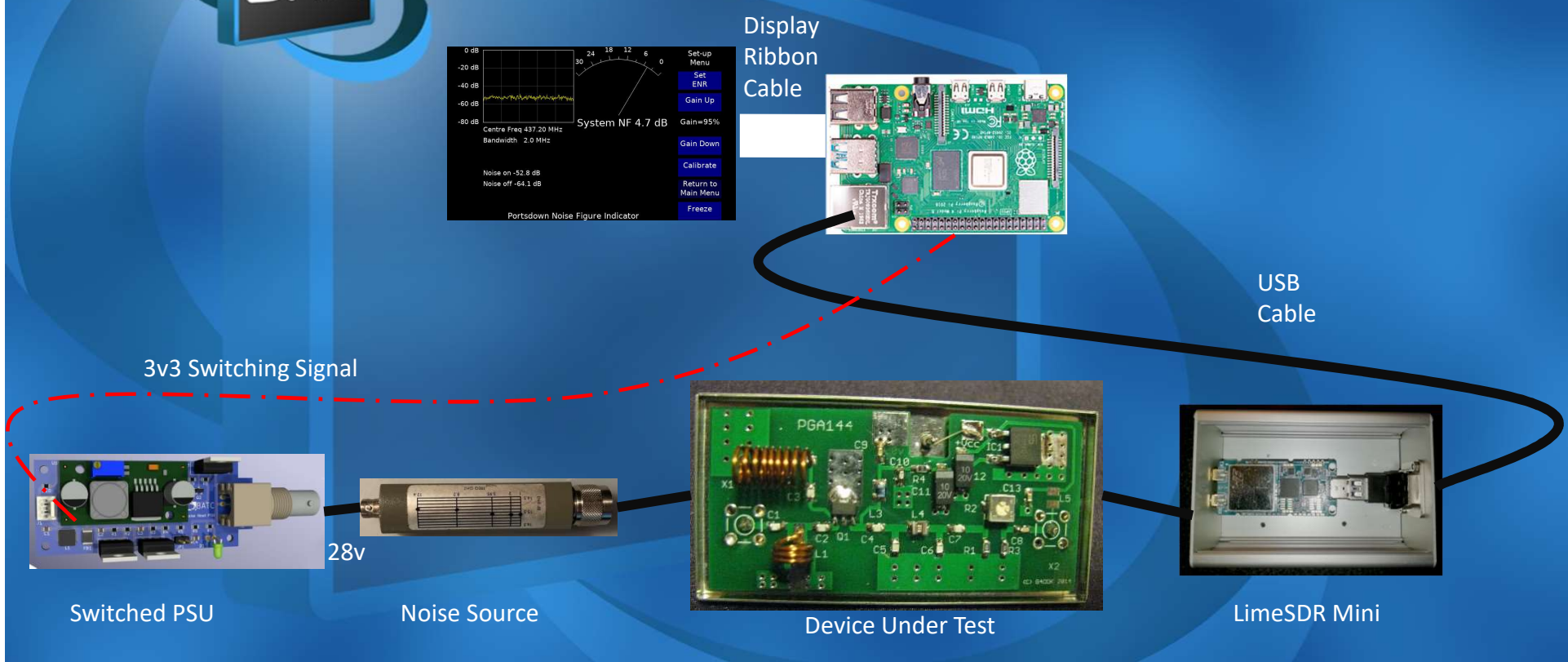

The logo for BATC, consisting of the letters 'BATC' in white on a dark blue rectangular background, which is slightly tilted and surrounded by a blue circular swoosh.

BATC

Noise Figure Notes

- SDR must be operating in linear region
- No significant signals in bandwidth
- Bandwidth?
- Minimise digital noise locally

Noise Source



BATC



- Calibrated Noise Sources are rare
- RF Design BBGen (ENR 24 dB 5 GHz) £84
add External Attenuator ?
- RF Design RXGen (ENR 10 dB 2.4 GHz)
Available from G3AAF (£60 BATC Members)
- Homebrew?



The logo consists of the letters 'BATC' in white, bold, sans-serif font, centered on a black rectangular background. This background is set within a blue, stylized speech bubble shape that has a circular motion effect around it.

BATC

Noise Source Switching PSU



- Commercial sources need 28v
- RF Design Sources need 12v or 13.5v
- Needs to be a clean supply
- BATC design (and PCB) available

BATC

Noise Figure Application



Centre Freq 437.20 MHz
Bandwidth 2.0 MHz

Noise on -52.8 dB
Noise off -64.1 dB

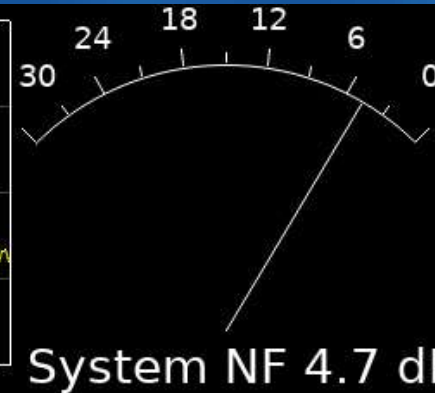

Set-up
Menu

Set
ENR

Gain Up

Gain=95%

Gain Down

Calibrate

Return to
Main Menu

Freeze

Portsdwn Noise Figure Indicator

BATC

Calibration

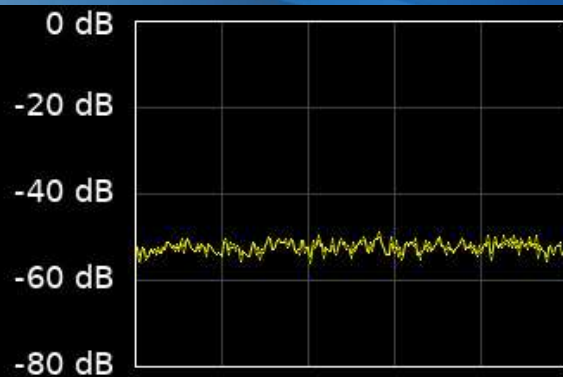

Centre Freq 437.20 MHz
Bandwidth 2.0 MHz

Noise on -52.8 dB
Noise off -64.1 dB

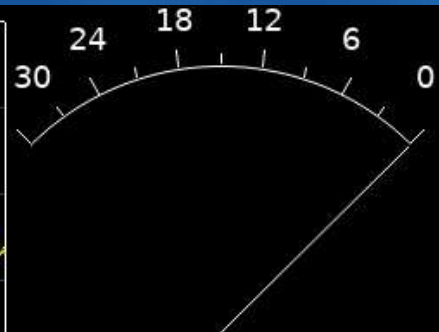

Device NF -0.1 dB

Device gain -0.0 dB

Set-up
Menu

Set
Input ENR

Gain Up

Gain=95%

Gain Down

Calibrated

Return to
Main Menu

Freeze

Portsdown Noise Figure Indicator

BATC

Device Gain and NF



Centre Freq 437.20 MHz
Bandwidth 2.0 MHz

Noise on -29.8 dB
Noise off -44.9 dB

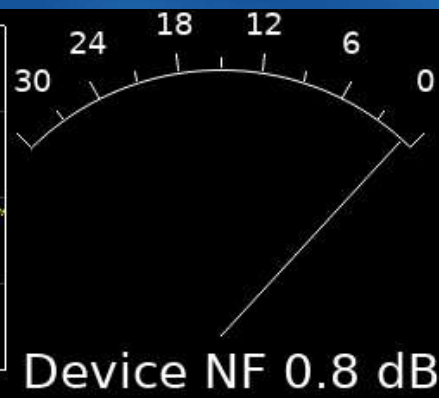

Device gain 23.2 dB

Set-up
Menu

Set
Input ENR

Gain Up

Gain=95%

Gain Down

Calibrated

Return to
Main Menu

Freeze

Portsdwn Noise Figure Indicator

The logo for BATC, featuring the letters 'BATC' in white on a black rectangular background, which is tilted and surrounded by blue curved lines.

BATC

Noise Figure Notes

- Not an exact science
- Beware LimeSDR Digital Noise
- Use attenuators for error-checking
- Beware changing source VSWR between noise on and noise off



Noise Level Meter

- Indicates average noise power
- Relative or Absolute
- Can indicate carrier level
- Relative to Noise or Absolute
- Pluto or LimeSDR

Sun Noise (Absolute)

BATC

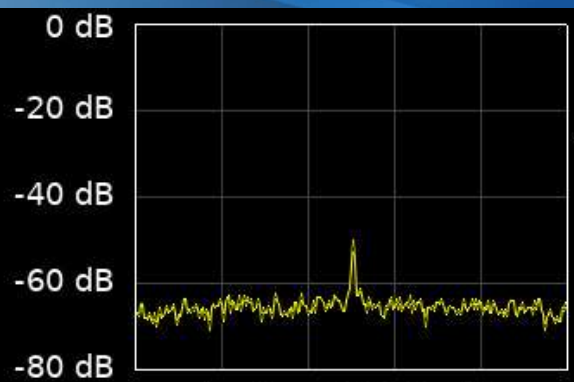

Centre Freq 740.00 MHz
Bandwidth 500.0 kHz

Noise now -65.7 dB
Baseline -71.7 dB

History span 100 sec

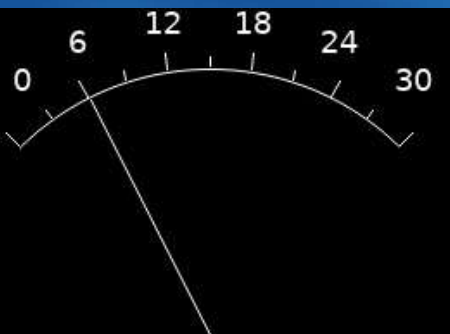

Noise Delta 6.0 dB



Set-up
Menu

Set
Baseline

Gain Up

Gain=95%

Gain Down

Establish
Baseline

Return to
Main Menu

Freeze

Portsmouth RF Noise Level Meter

BATC

Relative Noise

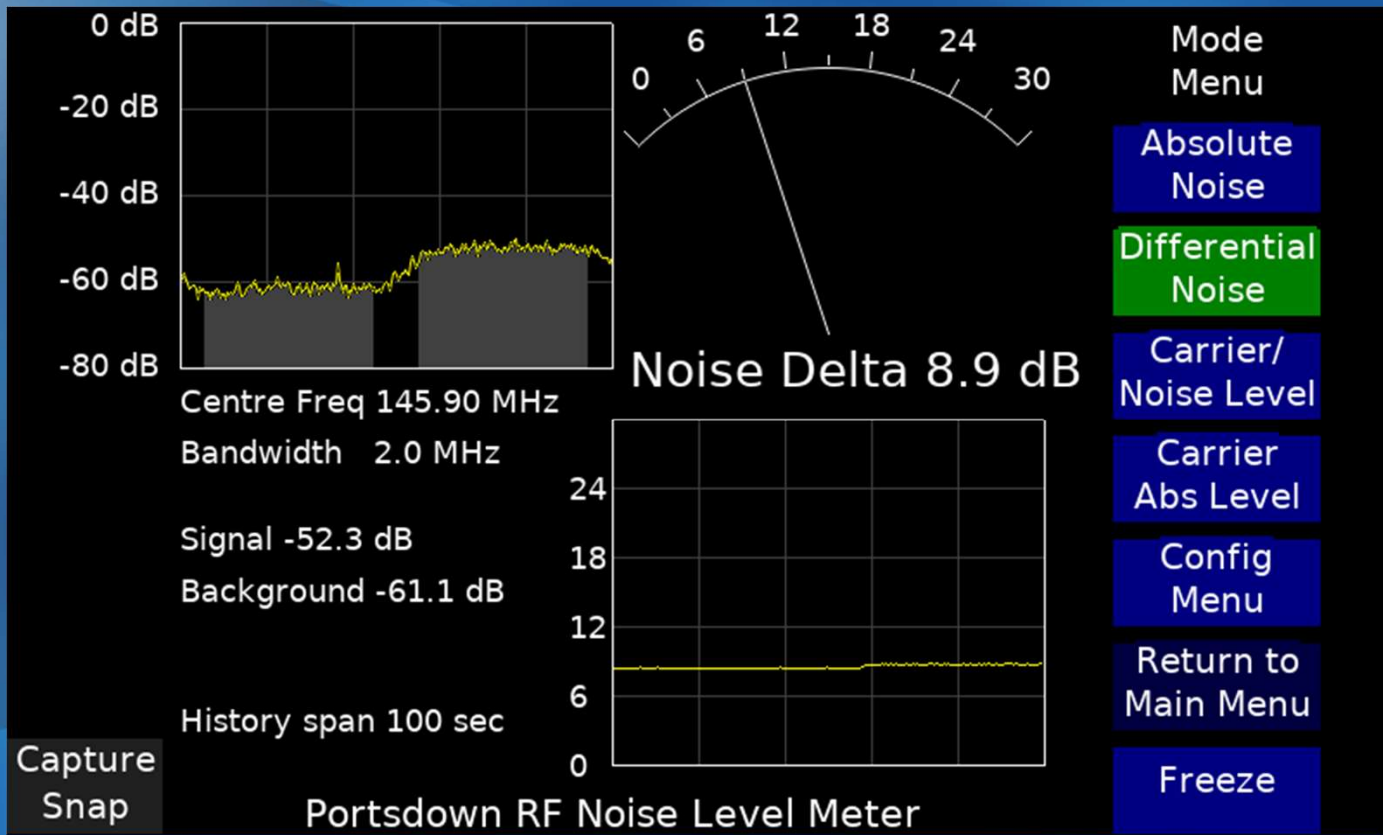

BATC

Carrier to Noise Level

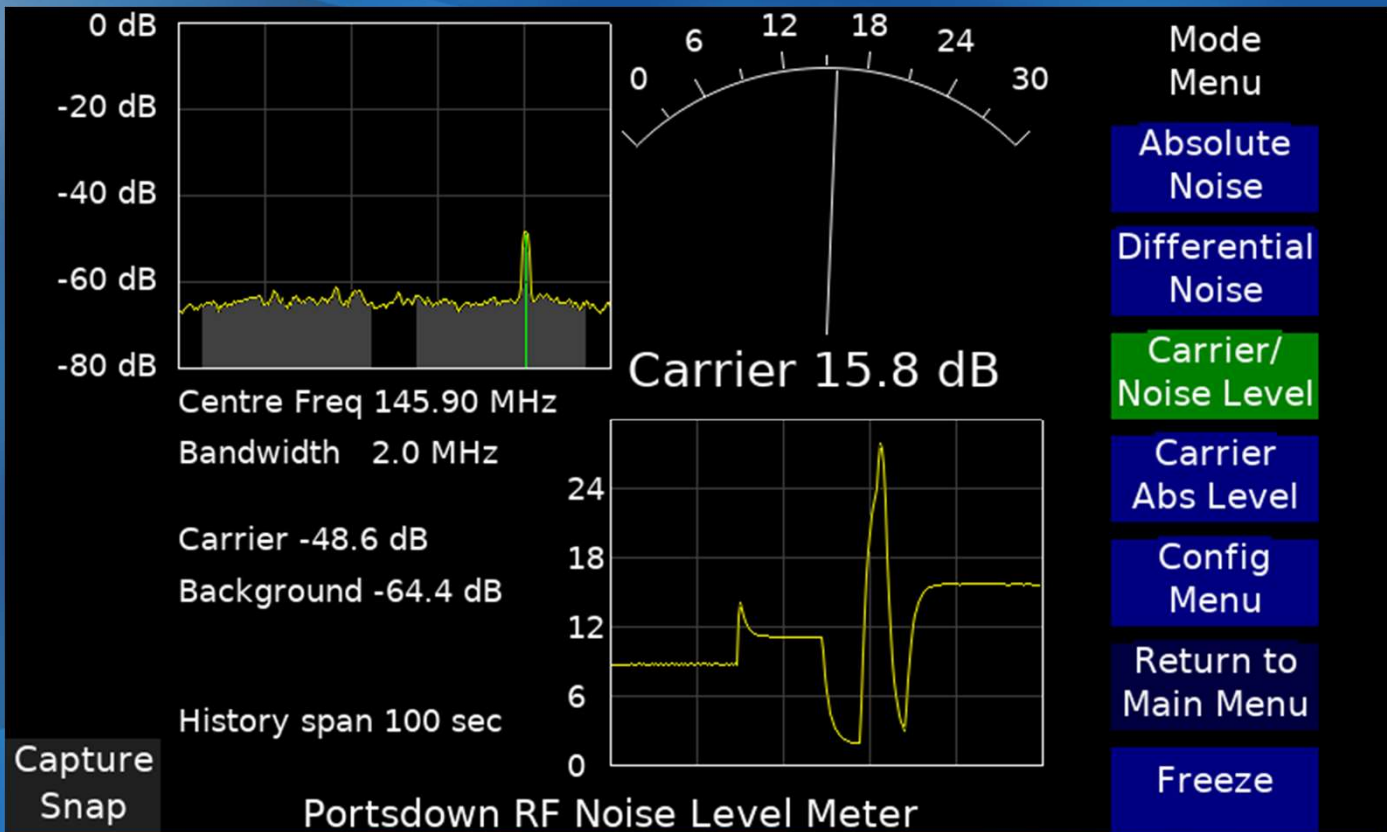

Absolute Carrier Level

BATC

0 dB
-20 dB
-40 dB
-60 dB
-80 dB

Centre Freq 145.90 MHz

Carrier 11.4 dB

0 6 12 18 24 30

Mode Menu

- Absolute Noise
- Differential Noise
- Carrier/Noise Level
- Carrier Abs Level**
- Config Menu
- Return to Main Menu
- Freeze

Capture Snap

11.4

24
18
12
6
0

Portsdown RF Noise Level Meter

BATC

Power Meter

- Needs external sensor
- AD8318
- MCP3002 A-D
- More sensors in future

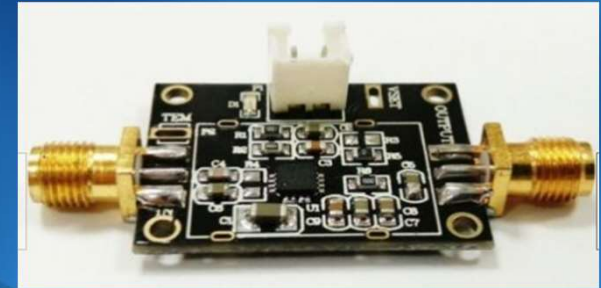

Power Meter Circuit

BATC

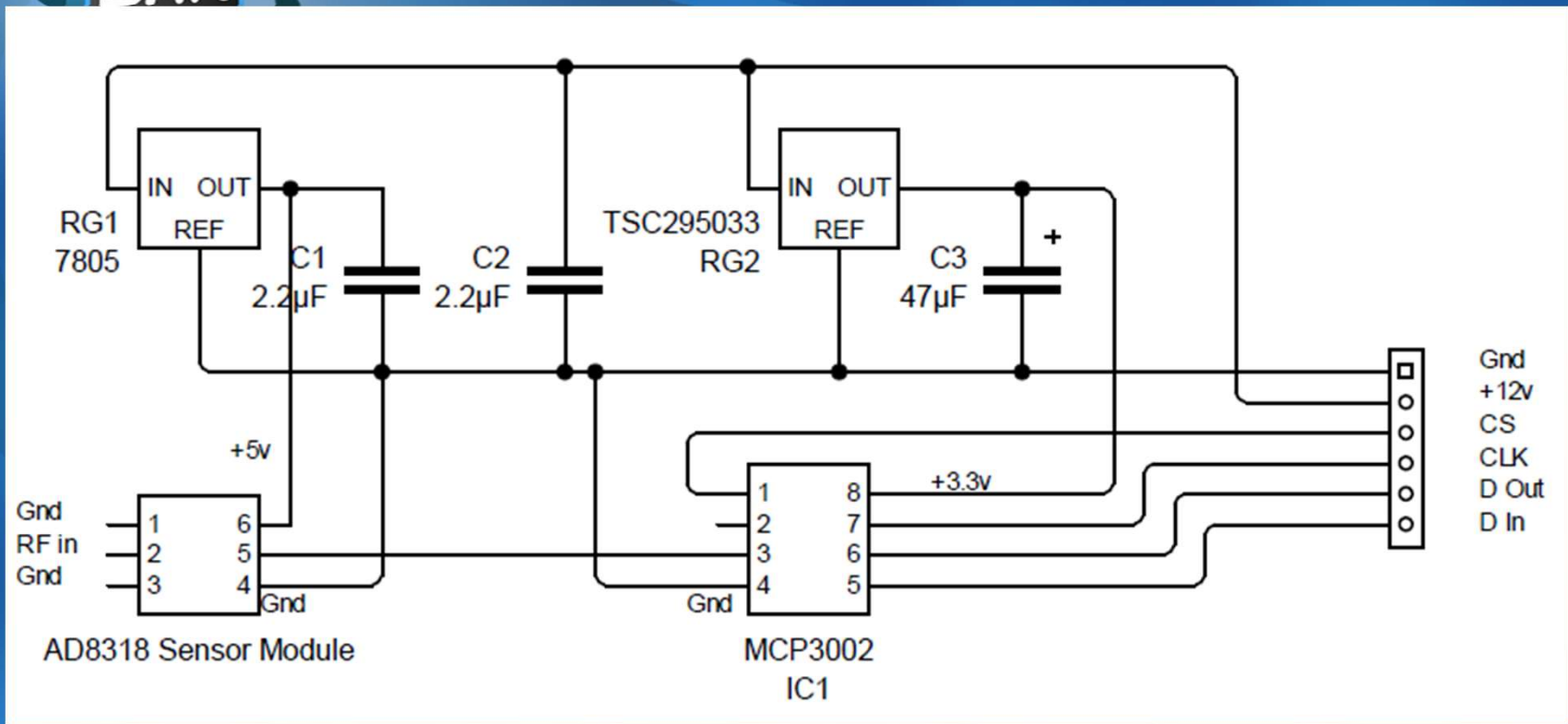

BATC

Meter Face



Sensor: ad8318-3

Portdown Power Meter

Main Menu

Settings

dBm

Mode

<-

->

System

Exit to
Portdown

Freeze



Power Meter Features

- Needle has “inertia”
- Selectable Ranges - dBm or mW
- Look-up table for linearity
- Calibration Factors can be entered
- Direct reading with attenuators
- An alignment tool – not an HP432!



The logo for BATC, featuring the letters 'BATC' in white on a dark blue rectangular background, which is partially enclosed by a blue circular swoosh.

BATC

RF Sweeper

- Combine the Signal Generator with the Power Meter
- Add some automation
- Frequency Response Sweeper

Sweeper - How?

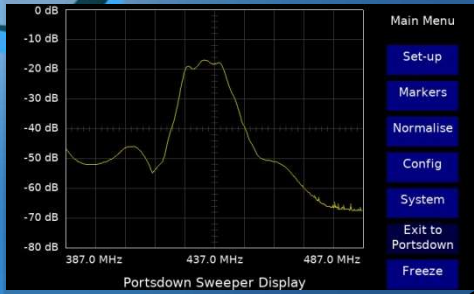

Display
Ribbon
Cable

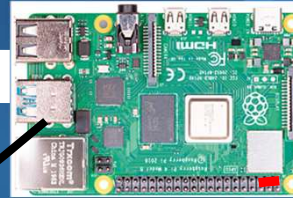

USB
Cable

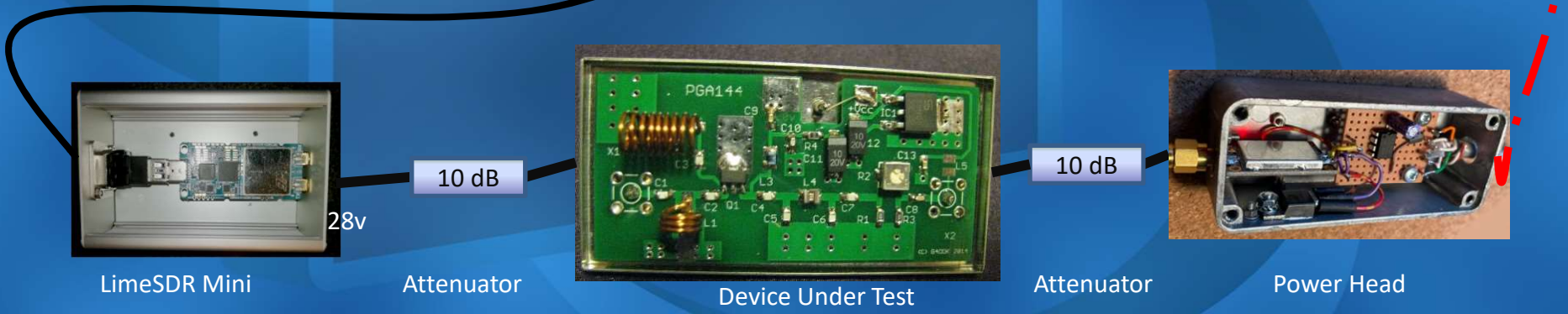

BATC

Checking a Filter

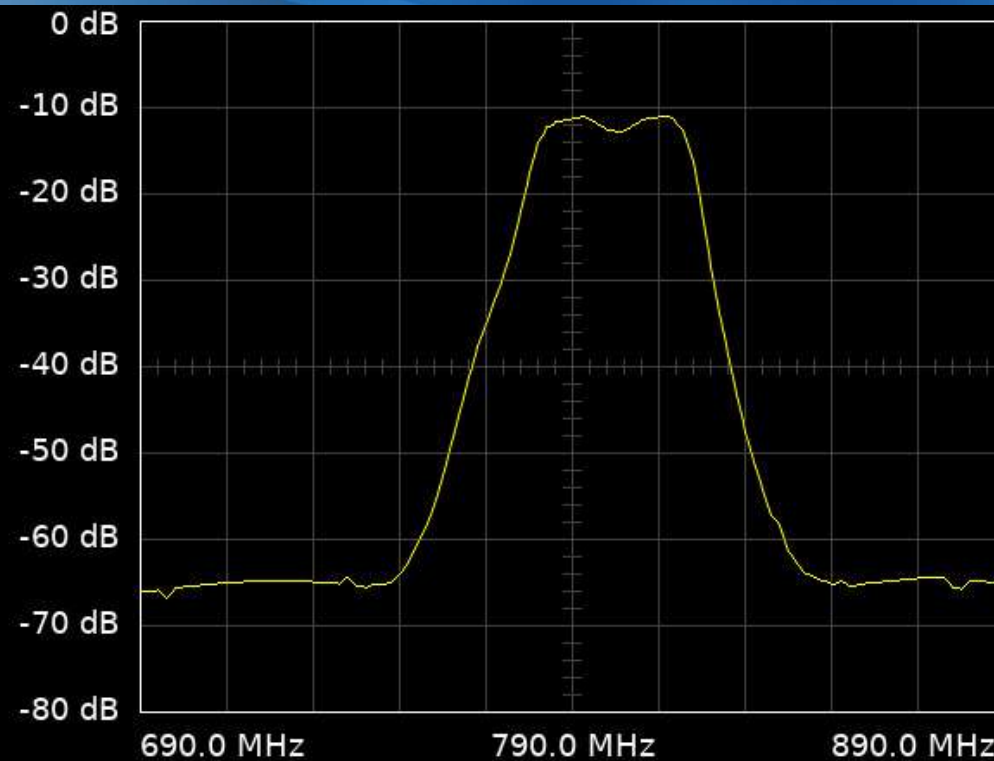

Portsdown Sweeper Display

Main Menu

Set-up

Markers

Normalised

Config

System

Exit to
Portsdown

Freeze

Sweeper Limitations

The logo for BATC, featuring the letters 'BATC' in white on a dark blue rectangular background, which is partially enclosed by a blue circular swoosh.

BATC

- Slow scan speed – Reduce samples?
- Responds to Spurii from Source
 - LimeSDR 3rd Harmonic 15 dB down?
- LimeSDR source only at present



BATC

XY Display

- For use with HP141T or HP8559
- Portsdown with added 2 IC interface
- Provides
 - 500 x 400 pixel image
 - Screen Capture and Freeze
 - Normalisation

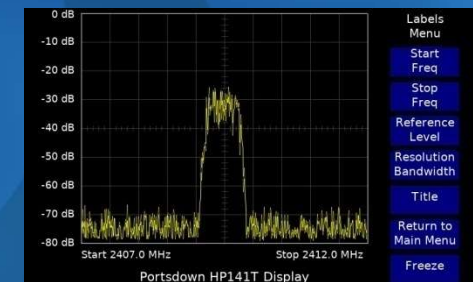

XY Display – How?

BATC

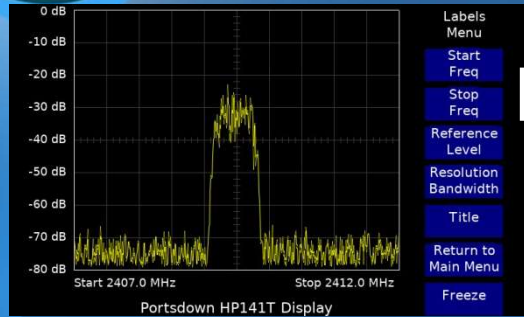

Display Ribbon Cable

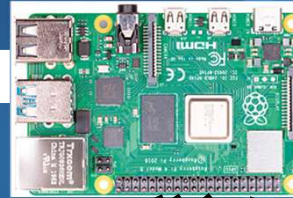

spi Data



Y input
Interface
X input

BATC

Typical Plot

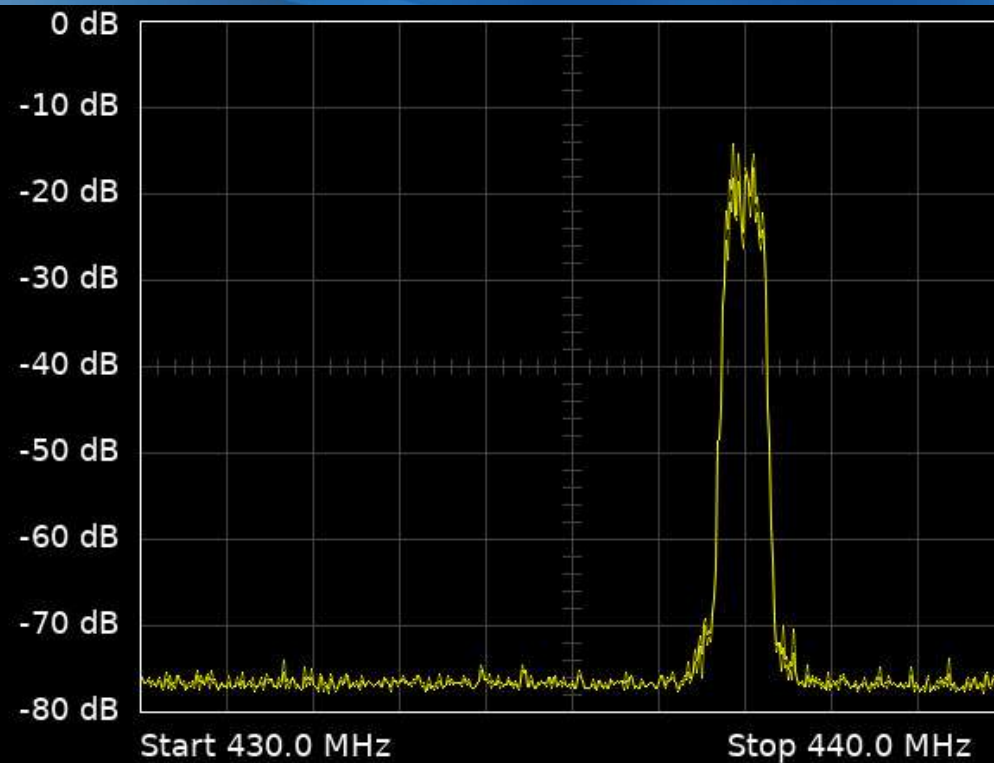

Labels
Menu

Start
Freq

Stop
Freq

Reference
Level

Resolution
Bandwidth

Title

Return to
Main Menu

Freeze

Portsdown HP8559A Display

BATC

XY Interface Circuit

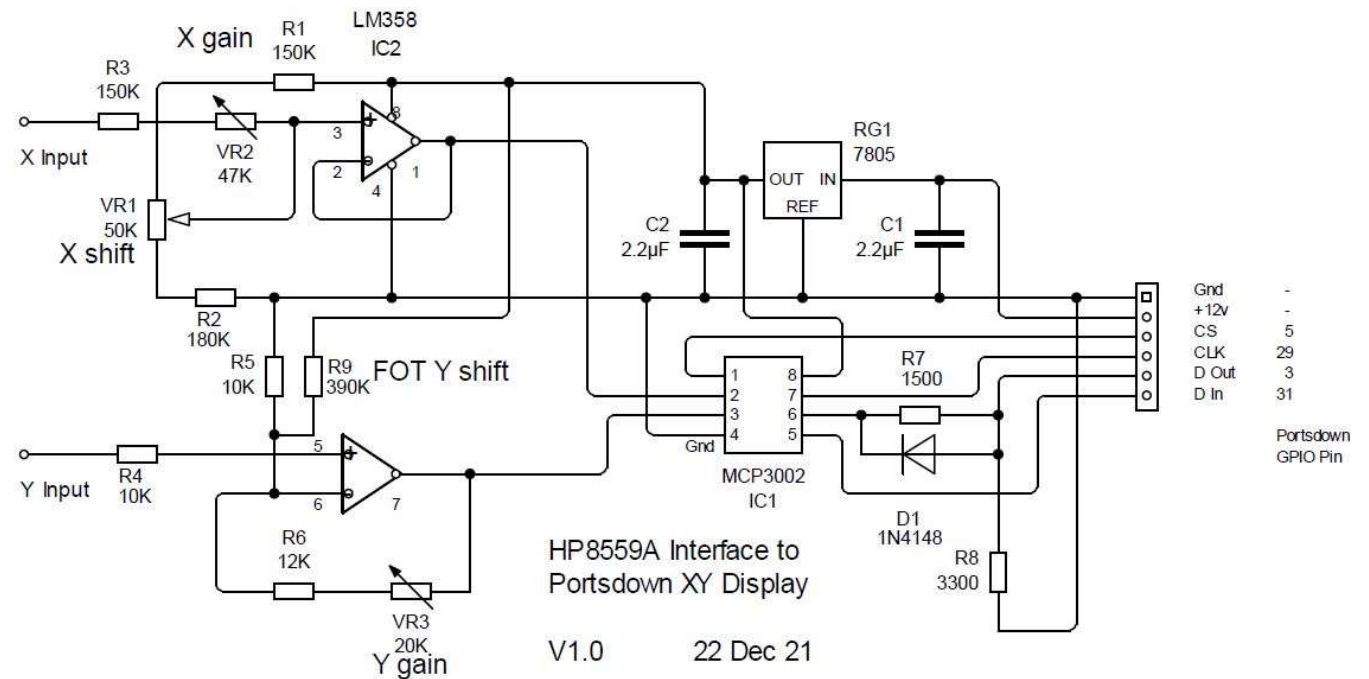

BATC

DMM Display and Logger

- Uses Parkside PDM300 Meter (£11.99 Lidl)
- Add an opto-isolator on serial output
- Enables large/remote/web display
- Logger and Battery calculator



The logo for BATC, featuring the letters 'BATC' in white on a dark blue trapezoidal background, which is surrounded by a blue circular graphic element.

BATC

DMM Display

12.07

Capture
Snap

Main Menu

Settings

dBm

Mode

<-

->

System

Exit to
Portsdown

Freeze

BATC

DMM Display

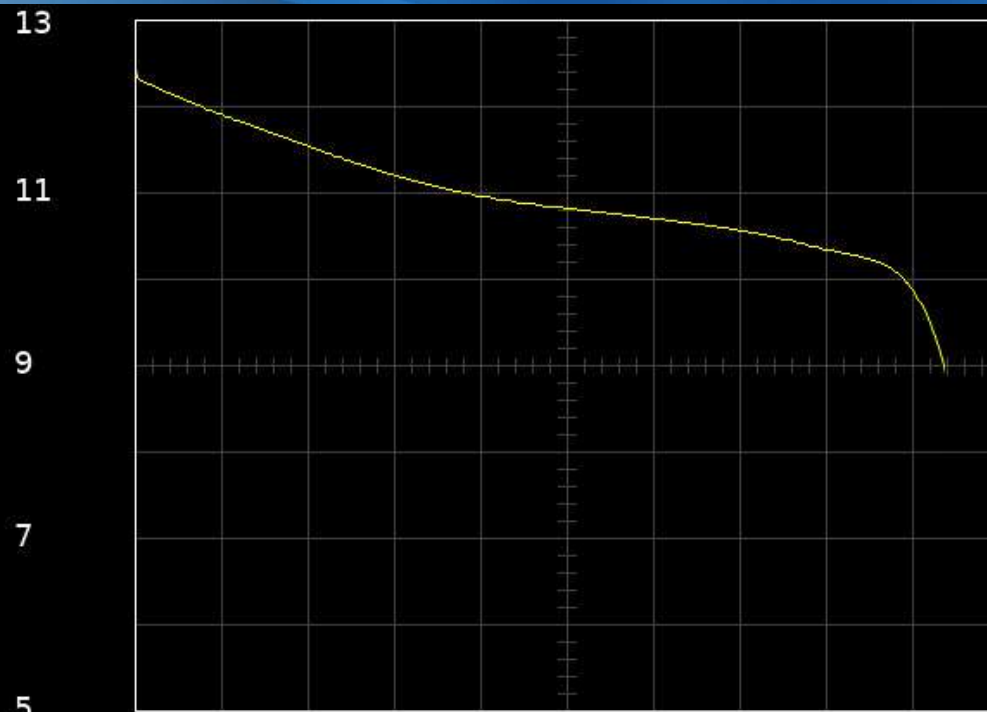

Actions
Menu 9

Load OFF

Start
Test

Reset
Test

Test
Complete

Save
.csv file

Return to
Main Menu

Freeze

Portsmouth Digital Multimeter Display

The logo for BATC, consisting of the letters 'BATC' in white on a dark blue rectangular background, which is partially enclosed by a blue circular graphic element.

BATC

Easy Wifi Connect

Select one of these WiFi Networks:

Page 1 of 1

- 1 TNSCAPE9C02B
- 2 PixienetG
- 3 DIRECT-8y-FireTV_7fd5
- 4 Hidden Network
- 5 PixienetG

Previous Page

Cancel

Select

Next Page

Web Control or view

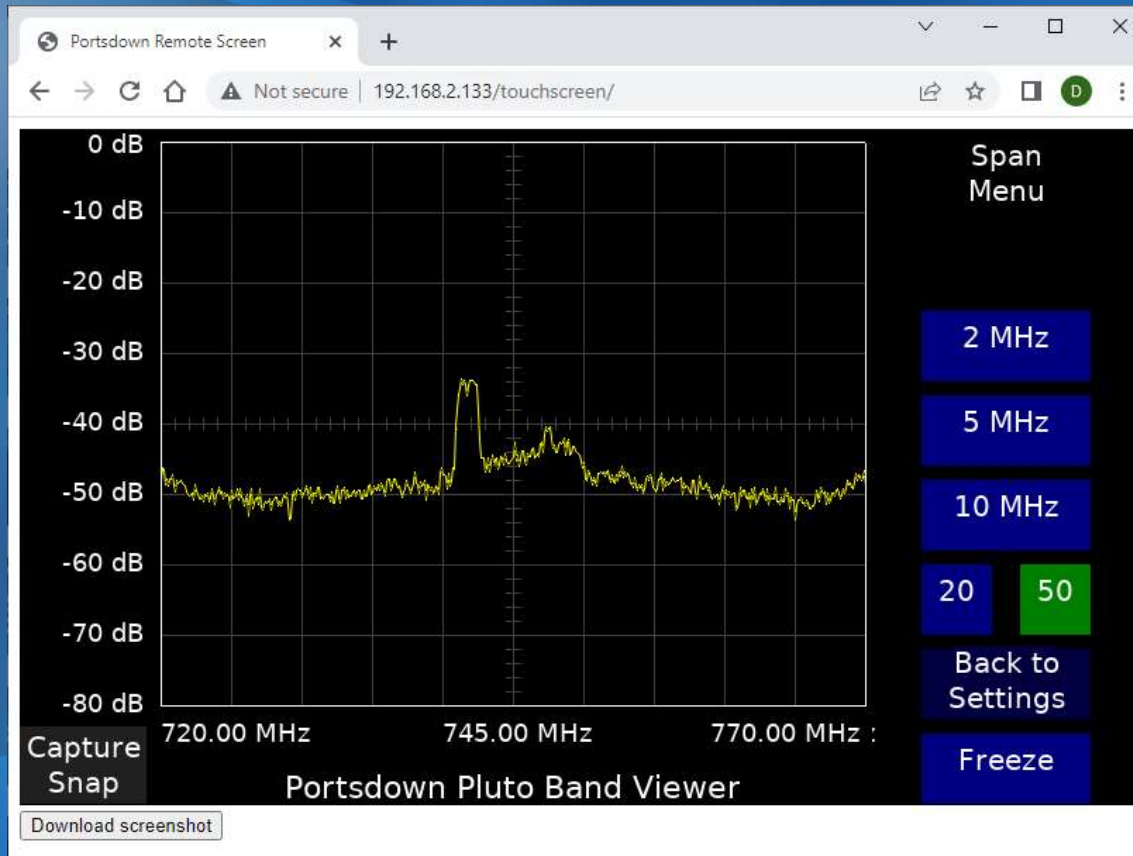

BATC

Portsdown Interface

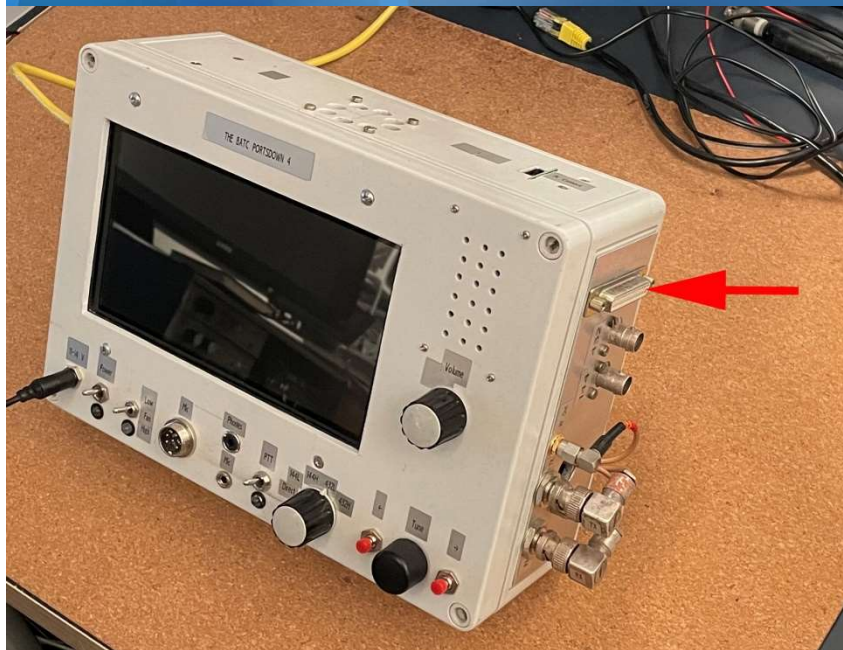

- Single interface for spi Power, Serial and Data
- Defined in CQ-TV



Summary

- Raspberry Pi, Touchscreen and peripherals provide a very capable platform for RF activities
- Peripherals **MUST** be the exact type – its not like Windows
- Open source (with one exception – DVB-T RX)
- BATC Wiki is primary information source
- Go and play with the applications and hardware



BATC

Questions